

ROLL AWAY® Series 7000

Installation Instructions

(For Surface Mount Doors)

TOOLS REQUIRED:

- Tape Measure
- Standard Screwdriver
- Phillips Head Screwdriver
- Drill Motor
- 1/8" Drill Bit
- 13/64" Drill Bit
- Hack or Chop Saw
- Framing Square
- Level

**IMPORTANT:
REVIEW ALL INSTRUCTIONS
THOROUGHLY
BEFORE STARTING STEP 1**



Partially Assembled Unit

PARTS INCLUDED:

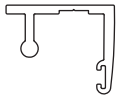

Head Track
#R6047



Track
#R6040



Closer
#R5600

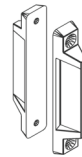

Handle Set
R7467XX

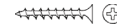

Flat Head Screws
#6 x 3/4"
#6 x 3/8"
#8 x 3/4"



Pan Head Screws
#6 x 1/4"
#6 x 1"

Step 1

Fabricate / Verify Part Lengths Required

Note: Please refer to page one of these instructions and verify your opening dimensions, and operation. Please refer to page 2 and verify your clearances.

- If your unit was purchased as a "kit" please refer to page 1 and the fabrication instructions.
- If your unit was purchased "assembled" the following has already been cut to size, verify and proceed to step 2.

Closer (#R5190)

Opening Height (Step 1) minus 1/16"

Track (#R6040 & #R6047)

Opening Width (Step 1) minus 2-1/16"

The completed hinge/housing assembly should measure your opening height minus 1/16".

Step 2 Install Housing/hinge

Drill three (3) 5/32" holes in the housing hinge, one approximately 2" from each end, one approximately in the middle. Locate the holes using the screw groove in the hinge (Figure 1).

Carefully, making sure not to damage the screen, install the Housing hinge against the stop in the jamb using three (3) #6 x 1" pan-head screws provided (Figure 2). Butt the hinge against the stop in the jamb as shown, and screw it into place.

Rotate the housing to its closed position. Snap the housing onto the hinge. Make sure the housing is fully seated on the hinge.

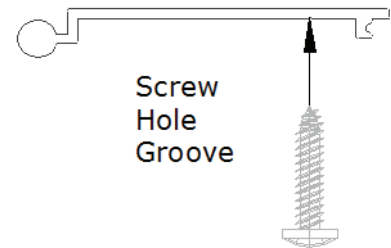

Figure 1

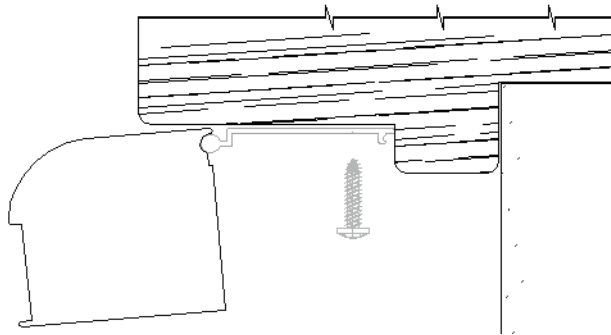

Figure 2

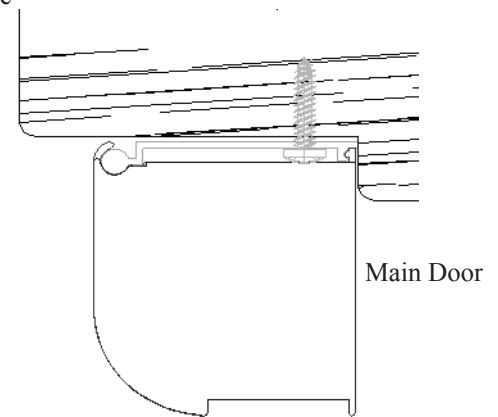

Figure 3

Step 3

Drill two (2) 5/32" holes in the closer (#R5600), approximately 4" from each end, using the mounting screw groove (Figure 4). Install Closer using #6 x 1" pan head screws provided, in the same position the hinge was installed, in the opposite jamb (Figure 5).

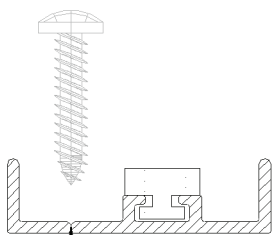

Figure 4

Mounting Screw Groove

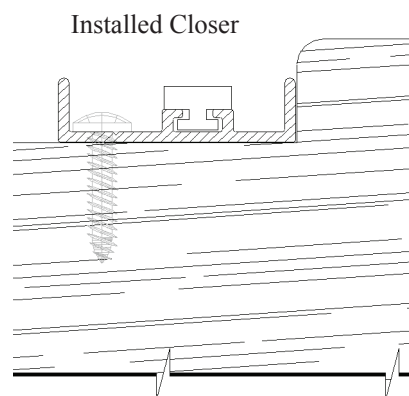

Figure 5

Step 4

Install Head Track

Carefully slide the Head Track (#R6047) into the Top Guide (Figure 6), insuring the weather-stripping is on the same side as the flat of the housing (Figure 7). Gently move the Head Track down, until the Closer end clears the Closer legs. Pocket the track in the closer (Figure 8), and fully seat the top track in the Housing end cap pocket, and screw in place using the #6 x 3/4" flat head screws provided.

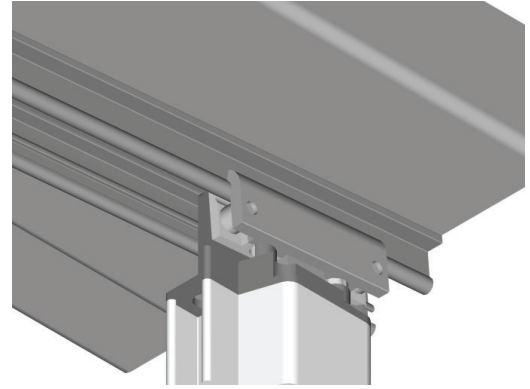

Figure 6

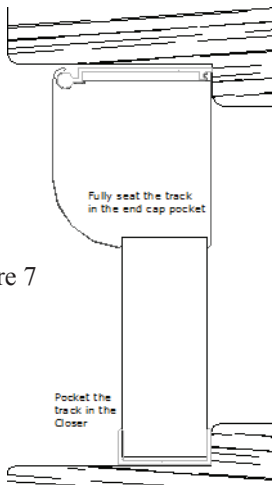

Figure 7

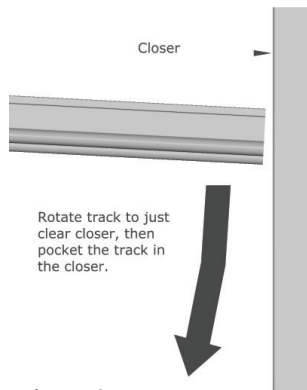

Figure 8

Step 5

Install Sill Track

Carefully repeat the steps for installing the top track.

Step 6

Install Handles

The handle set can be positioned as desired (Figure 10.) Set the inside handle in the desired location on the drawbar, insuring clearance for the main door handle/knob, and with a felt tip pen, mark the screw hole locations. Using a 3/32" drill bit, drill two holes and secure the handle to the drawbar using #8 x 3/4 flat head screws. Repeat for the outside handle.

Installation Complete

Make sure all components are properly installed. Check the overall operation of the door. Drawbar guides should move freely over both the bottom and top tracks and connect squarely with the closer. If properly installed, the door will want to return to the housing quickly after breaking contact with strike.

French Door Instructions

ADDITIONAL PARTS INCLUDED:

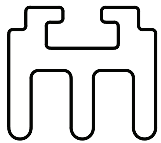

R6078



R5490

Amendments To Installation Instructions For French Door Opening

(See Page 1 for Step 1)

Step 2

Install Housing / Hinge

Install both Housing/hinge assemblies in the jambs directly opposite of each other.

Step 3

Install Closer

Closer is not required on French Doors. Strike installs in astragal.

Install Head and Sill Tracks

Steps 4-5

Both doors in a French Set will travel along the same tracks. (Note: If you purchased a French door kit as a KD, you will need to cut the top and bottom tracks to the opening width minus 4 1/16". Example: Opening width (Step 1) - 4 1/16". If the Door Opening is 72" cut the tracks at 67 15/16". It is strongly recommended that measurements are taken at the head and the sill, and the tracks cut specifically to fit these dimensions.)

The track rotate & pocket method may only be used on one side of the door. The opposite drawbar must be

“snapped” into place after the tracks are installed. It is important that the tracks be fully seated in the housing end cap pockets for proper door operation.

To avoid damaging the screen, it is recommended that you temporarily tape or otherwise restrain the drawbar/screen that will be “snapped in” out of the track area while the tracks are being installed. Install the tracks per steps 4 and 5, pocketing the tracks in the opposing housing end caps (instead of the closer). Use the #6 x 3/4 flat head screws provided to secure the tracks to the opening.

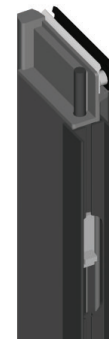

Drawbar with Astragal Pin.

(Pin is in Slot in Drawbar)

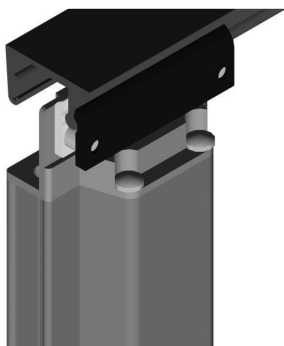

Step 6

“Snapping” in the opposite door

Carefully - and while making sure the screen is properly guided within the Top and Bottom Tracks- Pull on center of Drawbar until approximately two (2) feet of screen is exposed. Line up the top Drawbar Guide with the Top Track, and the bottom Drawbar guide with the Bottom Track (this will require the drawbar to be at a slight angle) and “snap” into place. Allow the screen to retract back into the housing. It is necessary to keep the Drawbar Guides aligned with the tracks during this process to prevent damage to the Guide assemblies.

Step 7

Install Astragal Stops

Install Astragal Stops (#R6490/R6495) into head and sill track. Fasten using one (1) #6 x 3/4" flat head screw through hole and into track. The astragal blocks are keyed on the bottom to fit in the screw groove in the track, and the stop upright will point at the operable door. Make sure stops are evenly placed, top and bottom, and hold stationary door in required position. The stop upright should be placed at that position in the track. Operable

door should easily open and close, latching at the stationary door when required. If more depth for the astragal pins are desired, a 7/32" drill bit can be used to drill through the astragal stops into the track substrate. Be careful here, that this process does not compromise the integrity of the building structure or weather barrier. R. Lang Company will not be responsible for any damage as a result of improper application of this process.

R6490 (RH)
R6495 (LH)



Step 8

Install Handles

The handle set can be positioned as desired (Figure 10.) Set the inside handle in the desired location on the drawbar, insuring clearance for the main door handle/knob, and with a felt tip pen, mark the screw hole locations. Using a 1/8" drill, drill two holes and secure the handle to the drawbar using #8 x 3/4 flat head screws. Repeat for the outside handle.

Astragal Block location

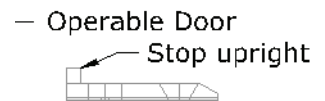
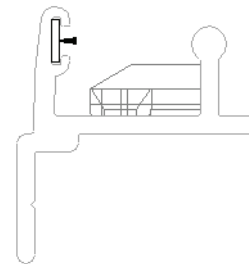

Installation Complete

Make sure all components are properly installed. Check the overall operation of the door. Drawbar guides should move freely over both the bottom and top tracks and connect squarely with the closer. If properly installed, the door will want to return to the housing quickly after breaking contact with strike.

Roll-Away® LIMITED WARRANTY

To the original purchaser, R. Lang Company warrants this product and its components parts to be free of defects on materials and workmanship for a period of one year from the date of purchase.

Damage caused by accident, improper installation or abuse, is specifically excluded from this warranty. Manufacturer's liability on any claim shall not exceed the cost of the product. In no instance shall manufacturer be responsible for consequential damage from the use of this product, including damage to existing door during installation or operation.

For a period of one (1) year from the date of purchase, any defective product or part may be sent, freight prepaid, to R. Lang Company, 8240 West Doe Avenue, Visalia, California (93291) for replacement or repair at no charge. Proof of purchase date and a pre-approved Return Materials Authorization must accompany any returned item. For further information about this warranty, contact the Customer Service Desk at R. Lang Company.

This warranty replaces any and all previous warranties, either written, oral, or implied, and is the only warranty made on this product by the R. Lang Company. This warranty gives you specific legal rights. Rights may vary from state to state.

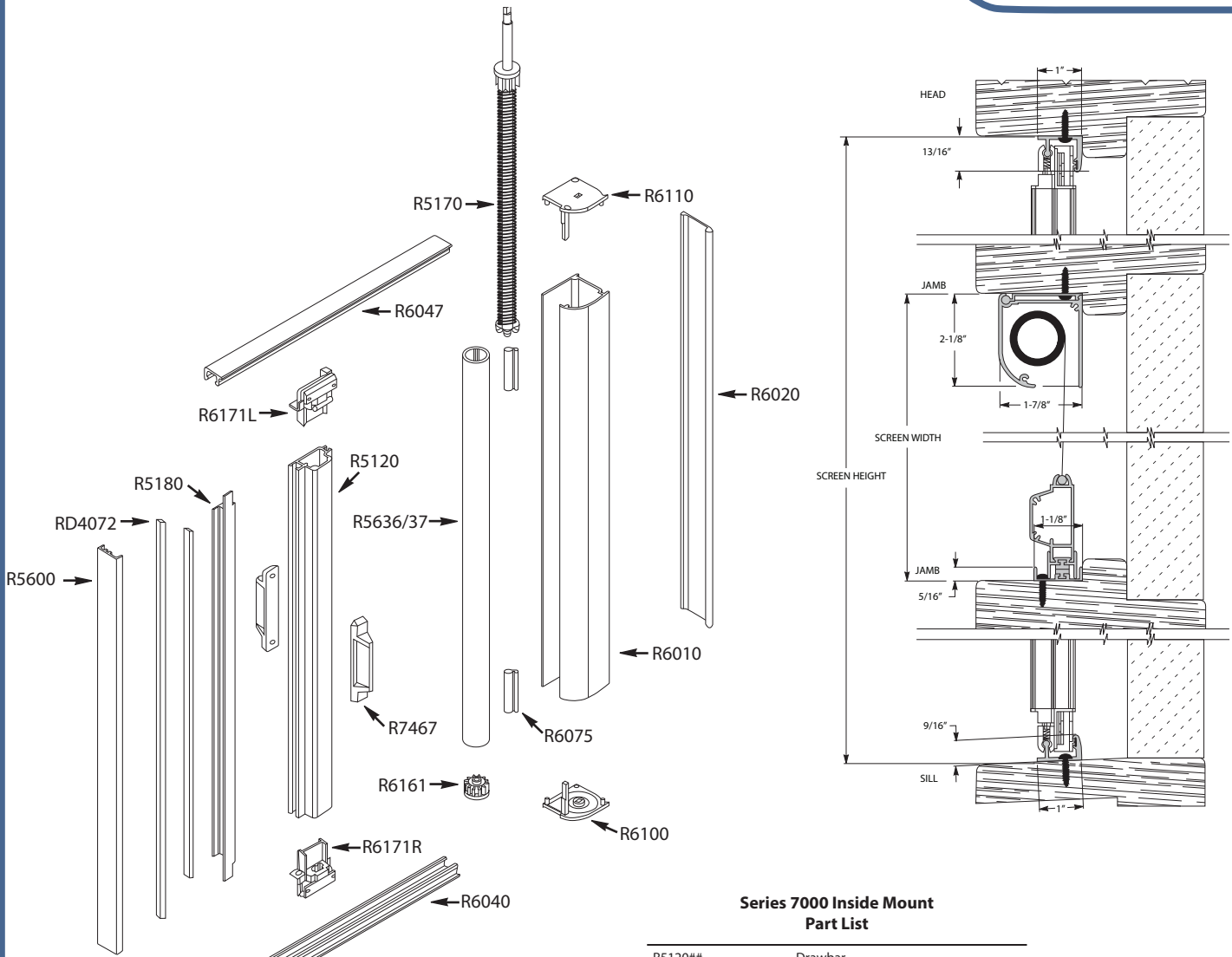

Series 7000 Inside Mount Part List

| | |
|---------------|-------------------------------|
| R5120## | Drawbar |
| R5636MF | Tube with Screen 82" |
| R5637MF | Tube with Screen 96" |
| R5170 | Spring Roller Assembly |
| R5180## | Astragal |
| R5600## | Closer Jamb |
| R6010## | Housing |
| R6020## | Hinge |
| R6040## | Sill Track |
| R6047## | Head Track |
| R6075BL/WH | PVC Cushion |
| R6110BL/WH | Housing End Cap - LH |
| R6100BL/WH | Housing End Cap - RH |
| R6161BL/WH | Bushing with Pin |
| R6171(BL/WH)L | Drawbar End Cap Assembly - LH |
| R6171(BL/WH)R | Drawbar End Cap Assembly - RH |
| R7467BL/WH | Pull Handle |
| RD4072 | Magnet |

- Door color



Disappearing Screens

Limited Lifetime Warranty ROLL AWAY®

Our History Speaks for Our Quality

The R. Lang Company was established in 1967, and retractable screen systems are how we began. We have always manufactured our products in the USA and continue to do so today. With over 50 years of successful retractable screen manufacturing behind us, we stay as we have always been, committed to making products that you're happy to add to your home.

We are confident in our Products & Processes and provide the following "Limited Lifetime Warranty".

Warranty Claim Process:

Any product rework must be pre-approved. In most cases, we recommend that the product be returned for correction to our facility in Visalia, California. This warranty includes the costs of shipping all defective products for the first six (6) months after the initial purchase. After the first six (6) months from initial purchase date, the buyer will be responsible for all shipping costs to/from our facility when required.

All warranty claims must be submitted by the original purchaser of the product from R. Lang Company for validation purposes. You must provide an original invoice number for verification. R. Lang Company reserves the right to inspect and test products to determine the validity of any Warranty Claim made or perceived, and R. Lang Company is the final judge as to its cause and rectification processes.

What Is Covered:

Our Limited Lifetime Warranty is valid for the original purchaser of our retractable window screen(s) only, and only when the screen has been installed permanently in a single location.

Our Limited Lifetime Warranty is non-transferable, and is the only valid Warranty, implied or otherwise, in connection with our retractable window screens. In no other event shall R. Lang Company be held liable for direct or indirect loss, consequential damage(s), or any other claims except as provided for in this warranty.

Our Limited Lifetime Warranty assures the workmanship and materials (Screen Mesh/Mesh Lock/ Weather Stripping Excluded) utilized in our retractable window screens will be free from defects, under normal use, to the original purchaser in a single location, for a lifetime. The R. Lang Company will repair or provide replacement product, at its election, free of charge, for any product proven to have a manufacturing defect during the lifetime of the product up to a maximum liability which shall be equal to the cost of replacement of the defective product. R. Lang Company shall in no event be liable for labor charges or other expenses whatsoever in connection with removal or installation of either the original or replacement product. In the event of repair or replacement pursuant to terms of this warranty, the original warranty shall apply to the repaired or replacement product. In lieu of replacement/repair, R. Lang Company, at its sole discretion, reserves the right to refund up to the amount paid by the original purchaser of the product but not including any installation/removal costs, consequential damage costs, or any other costs whatsoever. The term "defect" as used in this warranty is defined as imperfections which impair the utility/intended use of the retractable window screen and are generally not applied to perceived issues deemed 'aesthetic' or 'subjective judgements'.

Our Limited Lifetime Warranty is only valid when all retractable window screens are installed in accordance with R. Lang Company Installation Instructions (Available in both Text and Video formats). Retractable window screens installed incorrectly, in applications for which they were not intended, damaged during installation, or not installed in accordance with R. Lang Company accepted methods, are NOT eligible for coverage under this or any other warranty, implied or otherwise.

Our Limited Lifetime Warranty is intended to cover individual homeowners and does not apply to retractable window screens installed in commercial or public use applications. Our Retractable Screens are intended for Interior Applications Only, any Exterior Applications or constant exposure to outdoor elements will result in the Warranty being void.

Our Limited Lifetime Warranty expressly excludes the Screen Mesh and Mesh Lock components, and the Weather Stripping, which includes rips, tears, separation, fraying, and/or snags in or on screen material, or the detaching of the screen material from the inner tube or drawbar. Wrinkles in the mesh or puckering along its edges does not constitute a defect. Different mesh utilized, the screen's size, its location, and even atmospheric conditions, may cause variations in the mesh's appearance and/or smoothness of extension/retraction, and are therefore not considered "defects" under the terms of this warranty.

Our Limited Lifetime Warranty does not cover changes/fading/chalking in all coated finishes of all parts as it is an expectation this may take place with the passage of time but in no way affects the operation of the retractable window screen.

Our Limited Lifetime Warranty does not cover damage caused by misuse, abuse, negligence, scratching, corrosive atmosphere contaminants, vandalism, modifications, or any 'Act of God', or other causes reasonably beyond the control of the R. Lang Company.

Our Limited Lifetime Warranty assumes the original purchaser of the retractable window screen(s) will diligently perform all expected maintenance tasks as outlined by R. Lang Company (Available in both Text and Video formats). Retractable window screens lacking maintenance as outlined by R. Lang Company, or found to have a defect caused wholly or in part by improper maintenance, are NOT eligible for coverage under this warranty or any other warranty.

*This Document expresses the entire liability of R. Lang Company with respect to its retractable window screens.
Some States do not allow limitations or exclusions as set forth, so the above limitations or exclusions may not apply to you.*